

INSTALLATION INSTRUCTION

- 1.The fixture is for LED.
- 2.Before installation, make sure that the power supply is off.
- 3.Follow the steps as down below for installation or replacement of bulb.
- 4.After finishing every step, tighten the screws, have the fixture fixed, then connect the power supply.
- 5.It is recommended that these products are installed by a qualified electrician.

A.

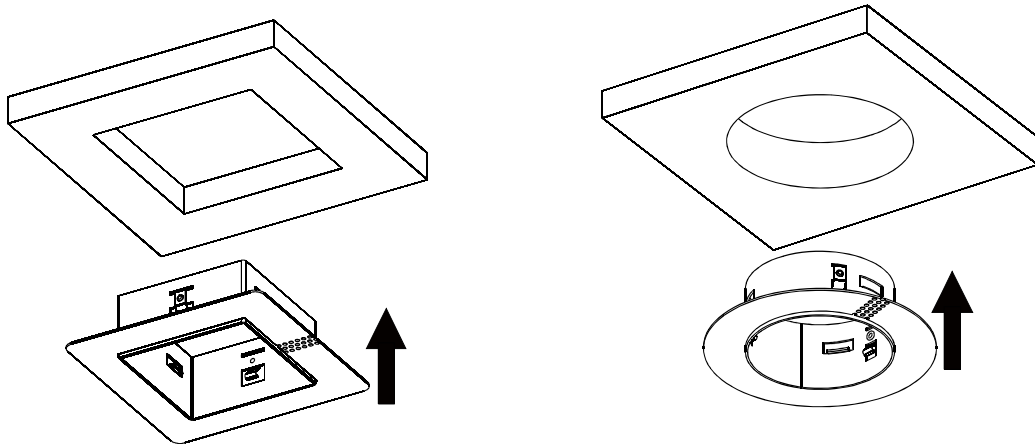

B.

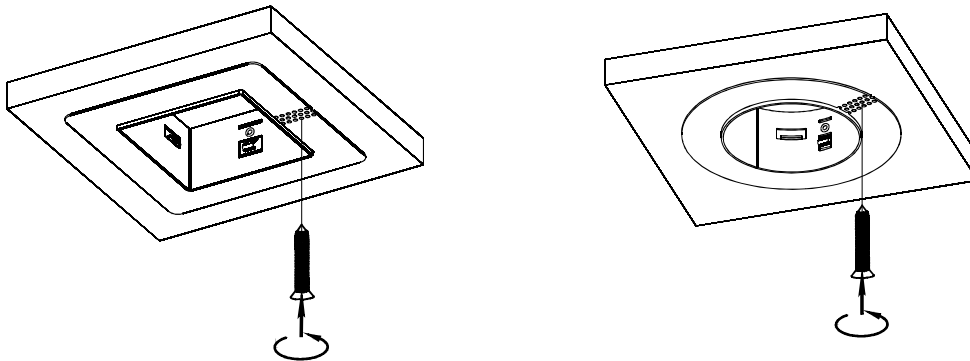

C.

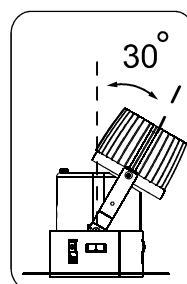
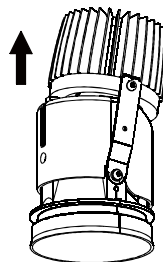
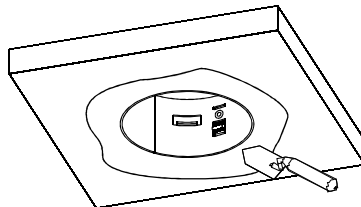
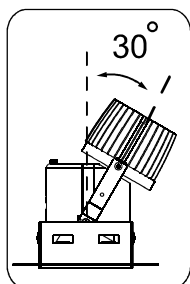
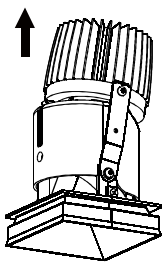
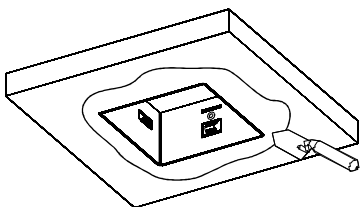

D.

